

Yealink

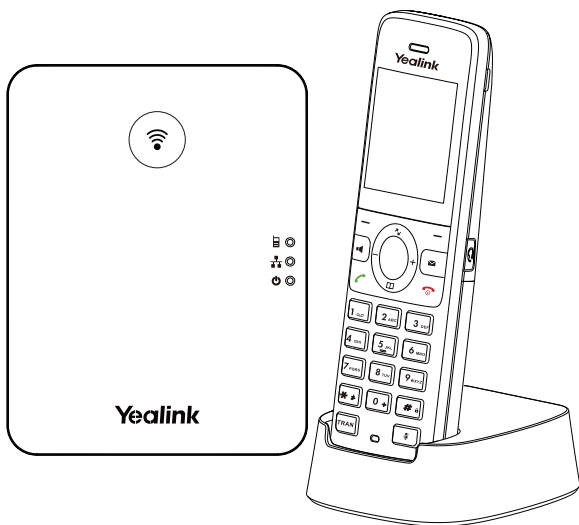

Yealink Documentation
support.yealink.com

DECT IP Phone W73P



English | Deutsch | Español | Français

Quick Start Guide (V1.3)

Table of Contents

English	1
Deutsch	5
Español	9
Français	13

W73P Package Contents



W73H Handset

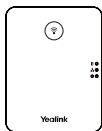

W70B Base Station



2 x Power Adapters



Base Stand



Ethernet Cable



Battery Cover



Battery



Belt Clip

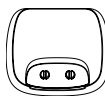

Charging Cradle



Quick Start Guide

Note: Yealink W73P DECT IP phone consists of one W70B base station and one W73H handset.

Assembling the DECT Phone

1. Connect the base station power and the network using method a or method b.

a. AC Power Option

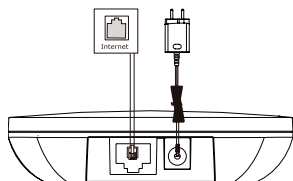

b. PoE (Power over Ethernet) Option

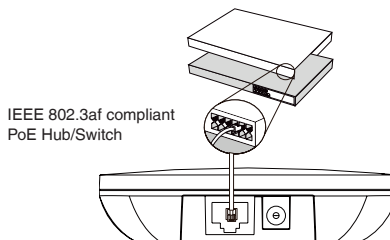

Note:

- If you choose method a, use Yealink supplied power adapter (5V/0.6A). A third-party power adapter may damage the base station.
- If you choose method b, you do not need to connect the power adapter. Make sure the hub/switch is PoE-compliant.

2a. (Desktop Installation) Attach and remove the base stand.

Attach the Base Stand

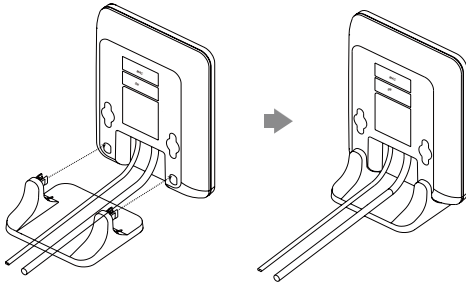

Align the snap-fits with the corresponding holes and push forward, snapping them into the holes.

Remove the Base Stand

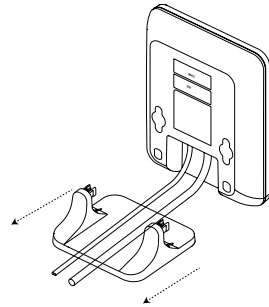

Remove the snap-fits from the holes horizontally.

2b. (Wall-Mount Installation) Attach the base station.

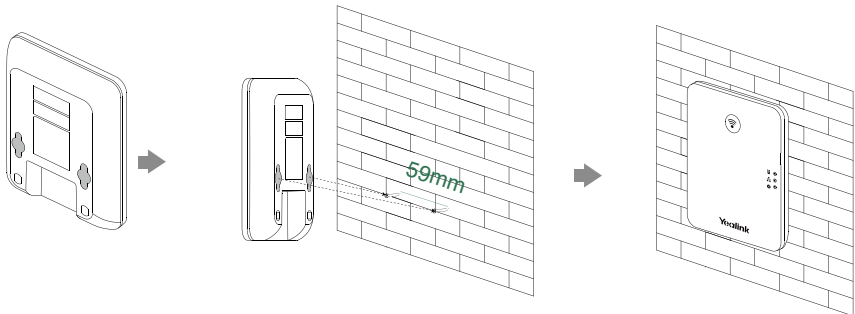

3. Insert the battery into the handset.

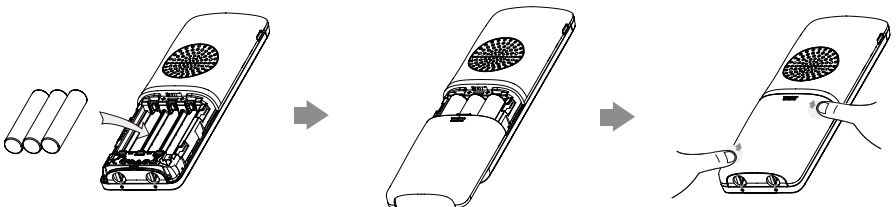

4. Attach the belt clip to the handset.

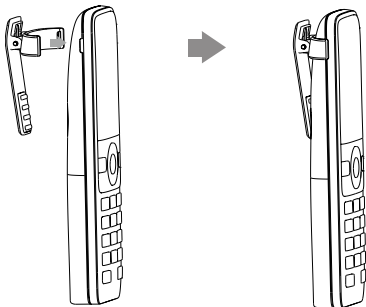

5. (Optional) Mount the charging cradle to the wall.

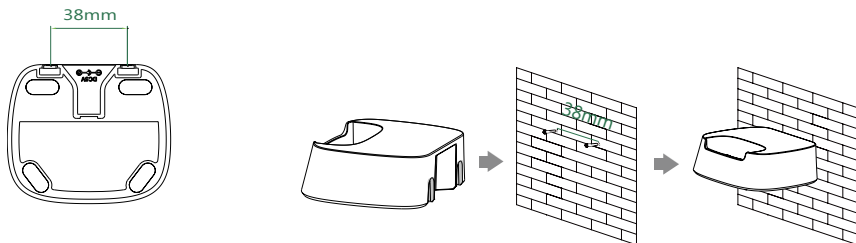

6. Connect the charging cradle and charge the handset.

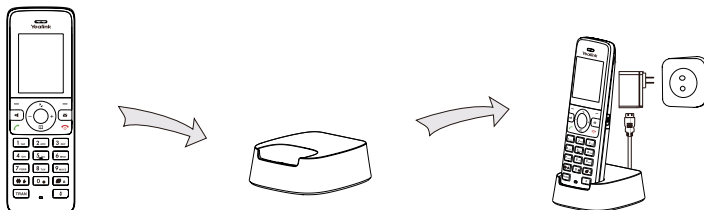

Note:

- Use Yealink-supplied power adapter (5V/0.6A). A third-party power adapter may damage the handset.
- Check the charging status on the top-right corner of the LCD screen.

Hardware Component Instructions

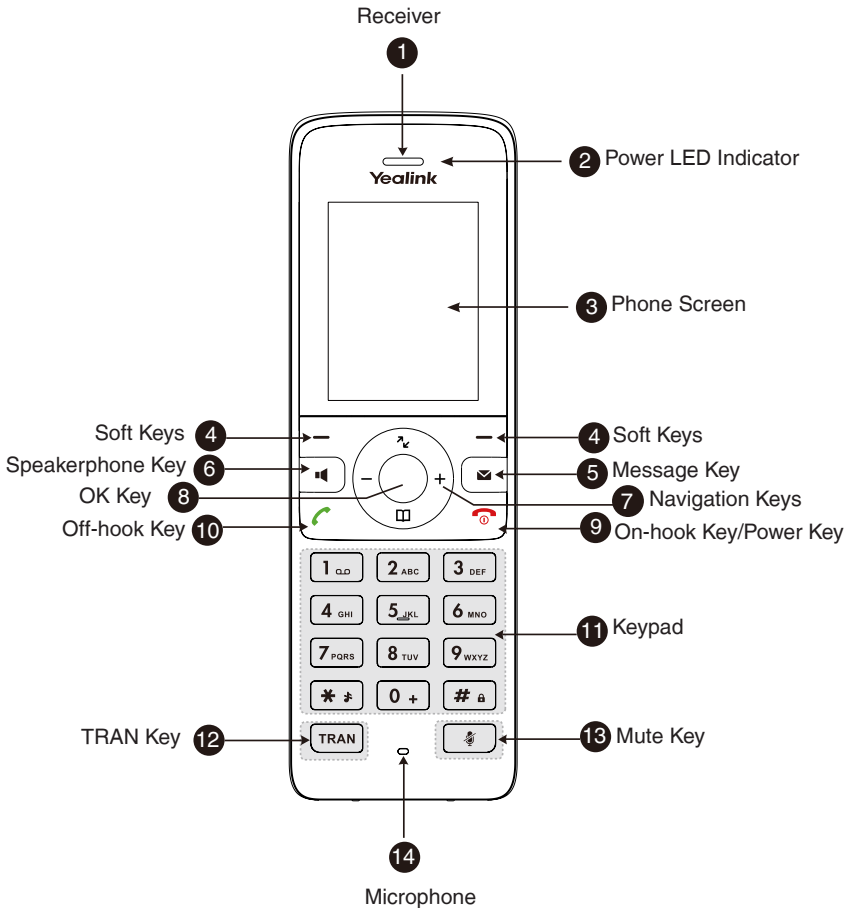

W73P Contenu de la boîte



Combiné W73H

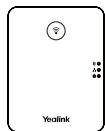

W70B Base



Deux adaptateurs d'alimentation

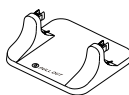

Socle de base



Câble Ethernet



Batterie couvrir



Batterie



Attache pour ceinture



Socle de chargeur



Guide de démarrage rapide

Remarque : Le Yealink W73P inclut une W70B base et un combiné DECT W73H.

Montage du téléphone DECT

1. Procédez à la connexion au réseau et à l'alimentation électrique de la station de base d'une des façons suivantes, comme illustré ci-dessous.

A. Option Alimentation secteur

B. Option PoE (Power over Ethernet)

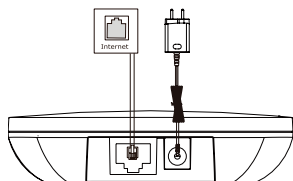

conforme à la norme IEEE 802.3af Hub/Interrupteur PoE

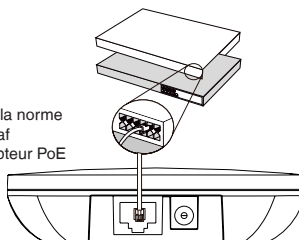

Remarque :

- Si vous choisissez la méthode a., utilisez l'adaptateur secteur fourni par Yealink (5 V/0,6A). L'utilisation d'un adaptateur tiers est susceptible d'endommager la station de base.
- Si vous choisissez la méthode b., vous n'avez pas besoin de brancher l'adaptateur secteur. Assurez-vous que le commutateur/routeur est compatible PoE.

2a. (installation de bureau) Attacher et Détacher le socle de la base.

Attacher le socle de la base

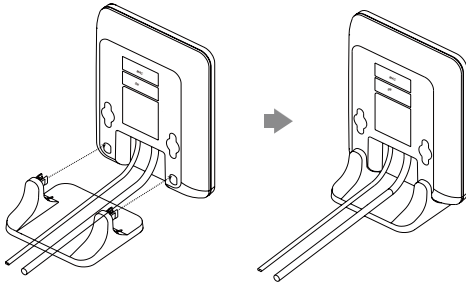

Aligner les crochets avec les trous correspondant et avancer pour les glisser dans les trous

Détacher le socle de la base

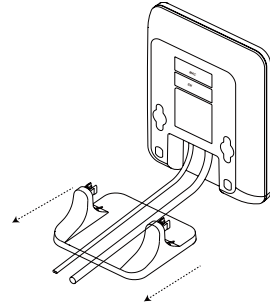

Détacher les crochets des trous horizontalement

2b. (Installation murale) Attacher la base.

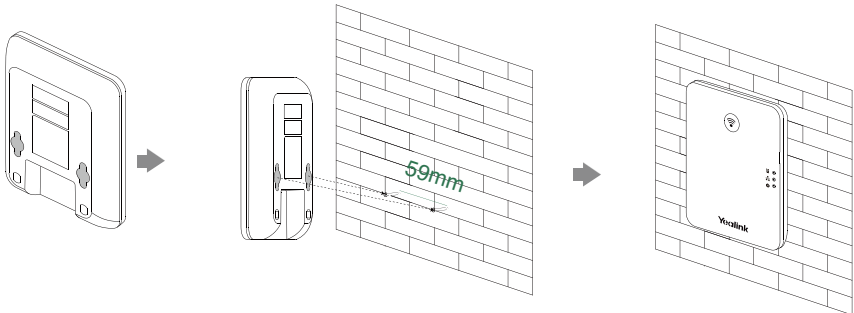

3. Insérez les piles dans le combiné.

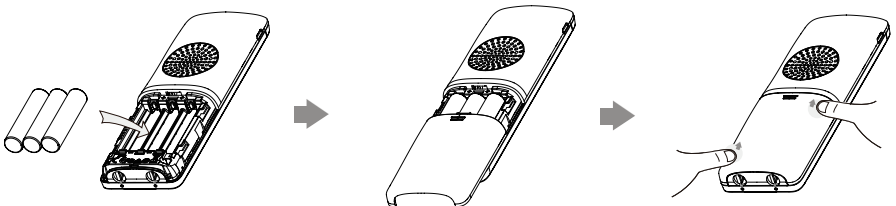

4. Attachez le clip de ceinture, comme illustré ci-dessous.

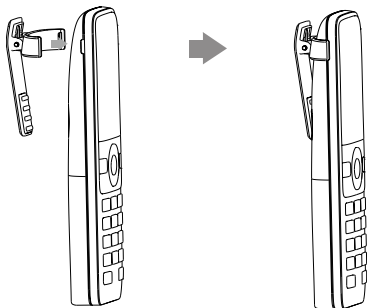

5. (Facultatif) Montez le socle chargeur au mur.

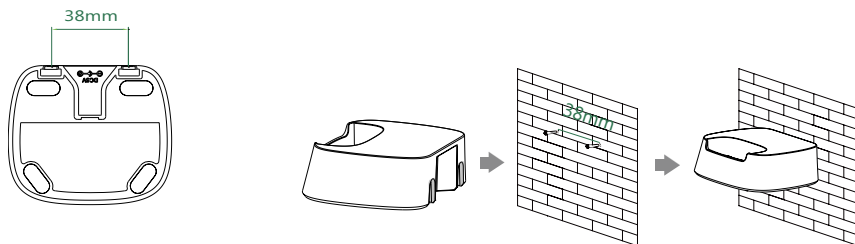

6. Raccordez le socle chargeur et chargez le combiné.

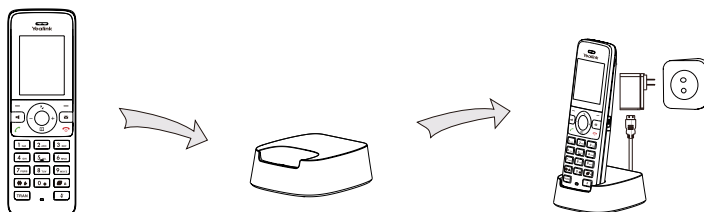

Remarque :

- Le combiné doit uniquement être utilisé avec l'adaptateur d'alimentation d'origine (5V/0.6A). L'utilisation d'un adaptateur tiers est susceptible d'endommager le combiné.
- Le niveau de charge du combiné est indiqué dans le coin supérieur droit de l'écran LCD.

Instructions du composant matériel

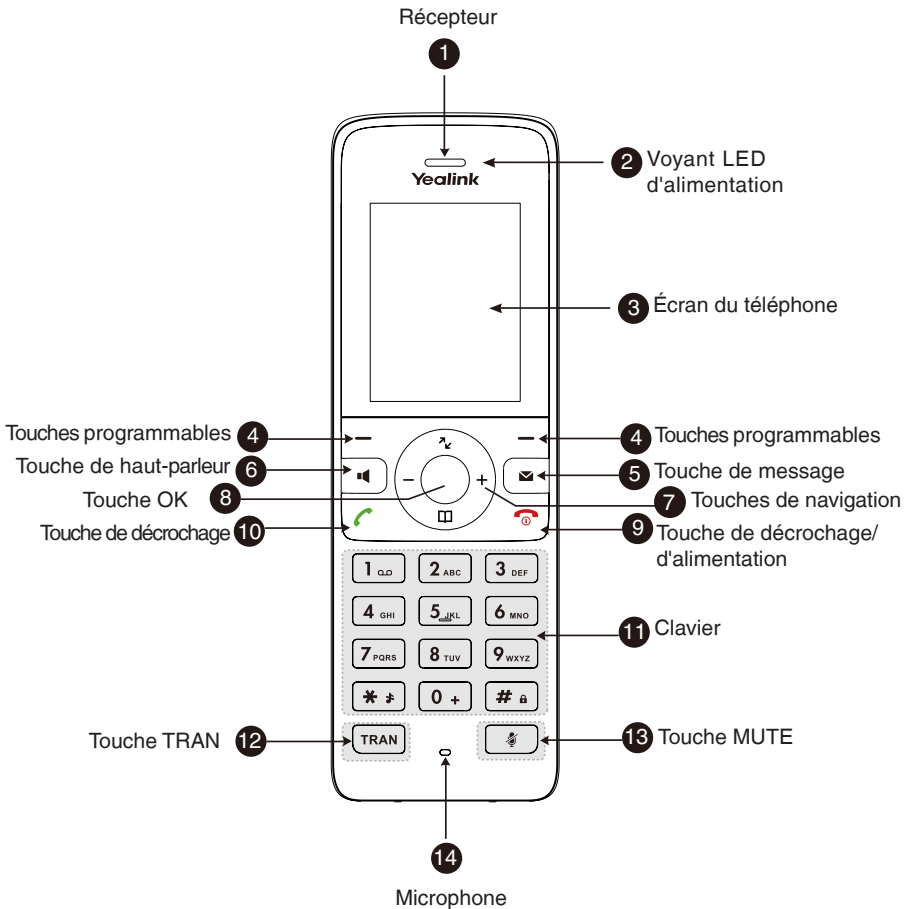

W73P Contenido de la caja



Auricular
W73H

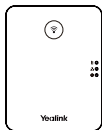

W70B Base



Dos alimentado-
res AC/DC



Soporte



Cable Ethernet



Tapa de batería



Batería recargable

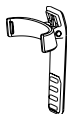

Clip de
cinturón



Base de carga



Guía de inicio
rápido

Nota: W73P Teléfono Inalámbrico DECT IP de Yealink consiste en una W70B base y un Handset W73H.

Instalación del teléfono DECT

1. Conecte la estación base a la red y la alimentación de una de las dos formas posibles:

a. Opción Alimentador

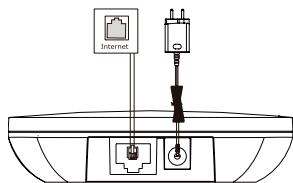

b. Opción PoE (Power over Ethernet)

conforme a IEEE
802.3af
Hub/Switch POE

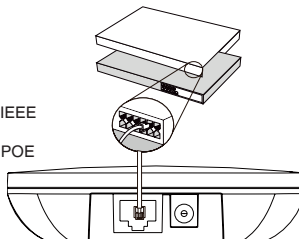

Nota:

- Utilice siempre el adaptador original de Yealink (5V/0.6A). El uso de un adaptador de terceros podría dañar la estación base.
- Si se proporciona la alimentación en línea (PoE), no necesita conectar el alimentador. Asegúrese de que el hub/switch sea compatible con PoE.

2a. (Instalación Sobremesa) Conectar y desconectar el soporte.

Conectar el Soporte

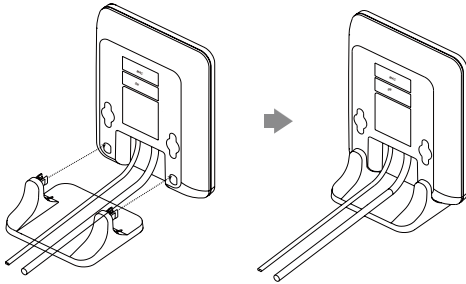

Alinear pestañas con agujeros correspondientes e empujar hasta encajar las pestañas

Desconectar el Soporte

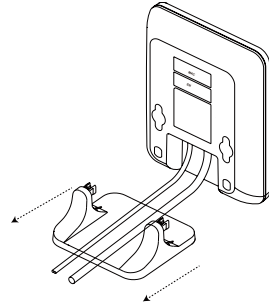

Tirar horizontalmente hasta soltar las pestañas.

2b. (Montaje en la pared) Conectar la estación base.

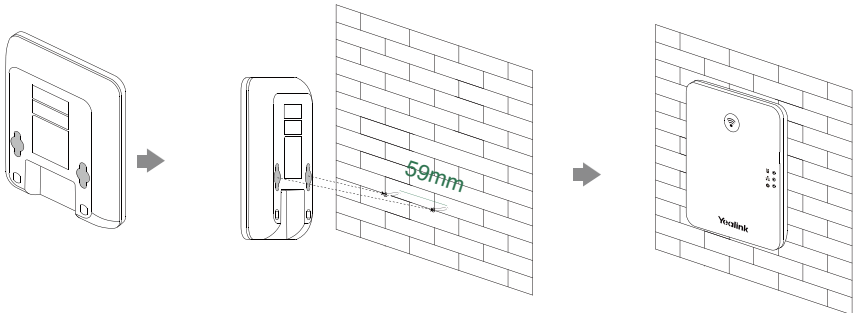

3. Introduzca las baterías en el teléfono:

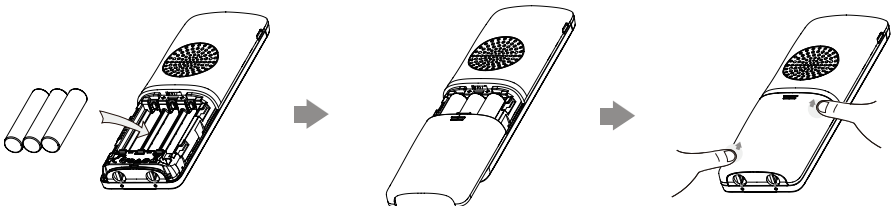

4. Coloque la pinza para el cinturón como se muestra a continuación:

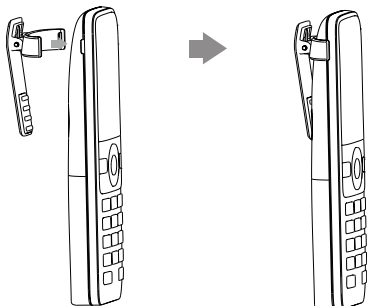

5. (Opcional) Coloque la base de carga en la pared.

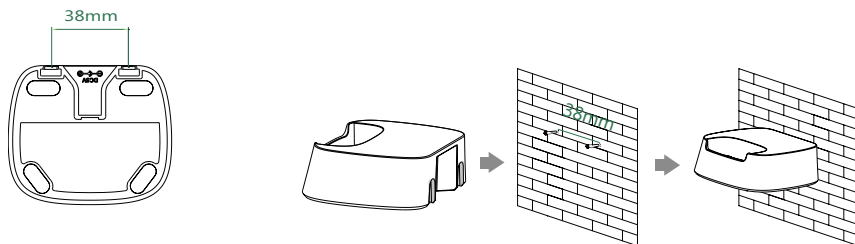

6. Conecte la base de carga y cargue el teléfono.

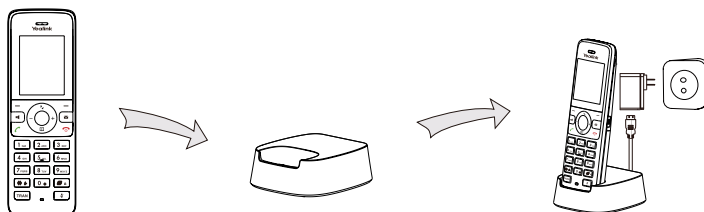

Nota:

- El teléfono debe usarse únicamente con el alimentador original (5V/0.6A). El uso de un adaptador de terceros podría dañar el teléfono.
- El estado de carga del teléfono se indica en la esquina superior derecha de la pantalla LCD.

Instrucciones de Componentes de Hardware

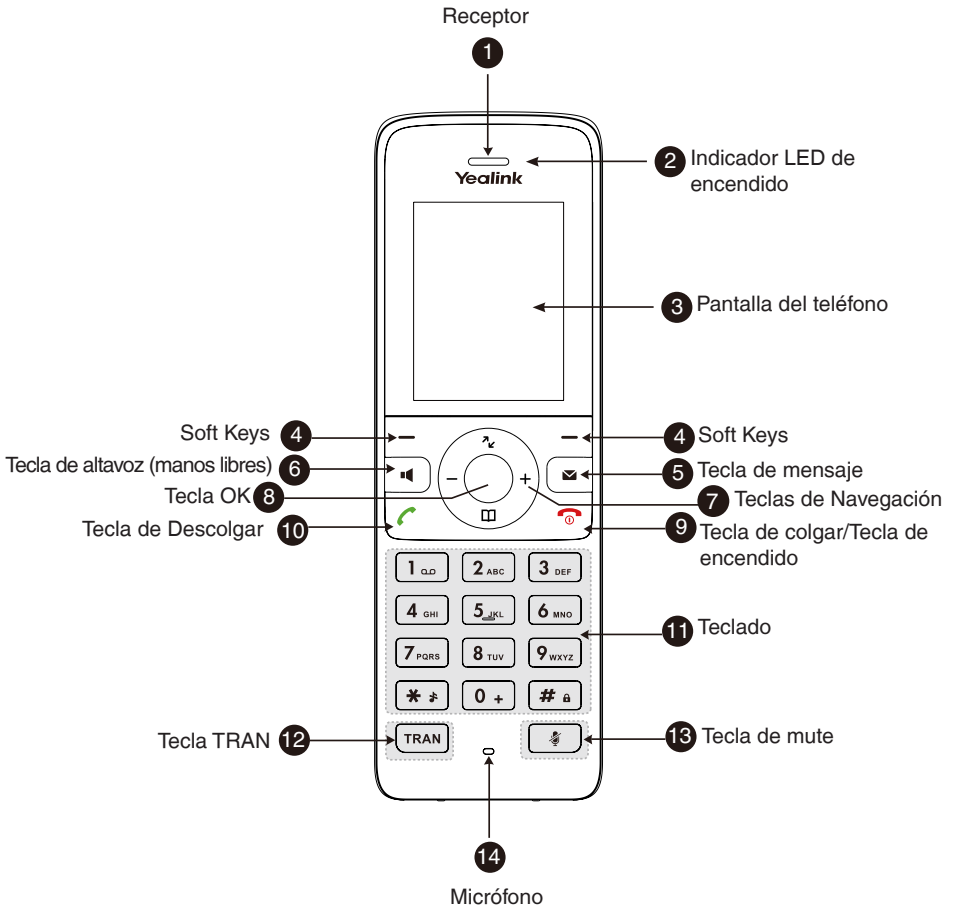

W73P Verpackungsinhalt



W73H
Mobilteil

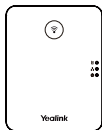

W70B Basisstation



Zwei Netzteile

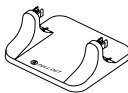

Basisständer



Ethernet-Kabel



Batterieab-
deckung



Wiederauflad-
bare Batterie



Gürtelclip

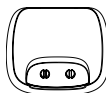

Ladestation



Kurzanleitung

Hinweis: Das Yealink DECT IP phone W73P besteht aus einer W70B Basisstation und einem W73H-Mobilteil.

Das DECT-Telefon zusammensetzen

1. Stellen Sie die Basisstation Stromversorgungs- und Netzwerkverbindung anhand Methode a oder Methode b her.

a. Option Wechselstromversorgung

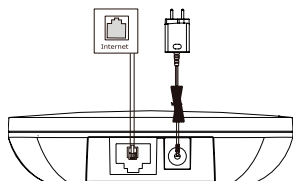

b. Option Power-over-Ethernet (PoE)

IEEE 802.3af-konform
PoE Hub/Switch

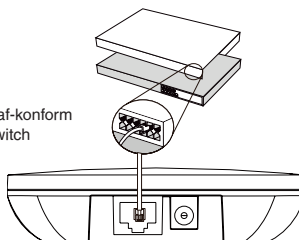

Hinweis:

- Wenn Sie sich für Methode a entscheiden, verwenden Sie das von Yealink mitgelieferte Netzteil (5V/0,6A). Ein Netzteil eines Drittanbieters kann das Basisstation beschädigen.
- Wenn Sie sich für Methode b entscheiden, müssen Sie das Netzteil nicht anschließen. Stellen Sie sicher, dass der Hub/Switch PoE-konform ist.

2a. (Installation auf einer Arbeitsfläche) Anbringen und Entfernen des Standfußes.

Anbringen des Standfußes

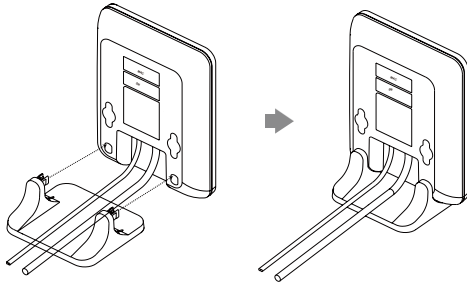

Richten Sie die Einrasthaken an den entsprechenden Öffnungen aus und drücken Sie diese in die Öffnungen hinein bis sie einrasten.

Entfernen des Standfußes

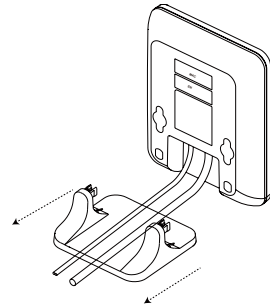

Entfernen Sie die Einrasthaken indem Sie sie in horizontaler Richtung aus Öffnungen herausziehen.

2b. (Wandmontage) Anbringen der Basisstation

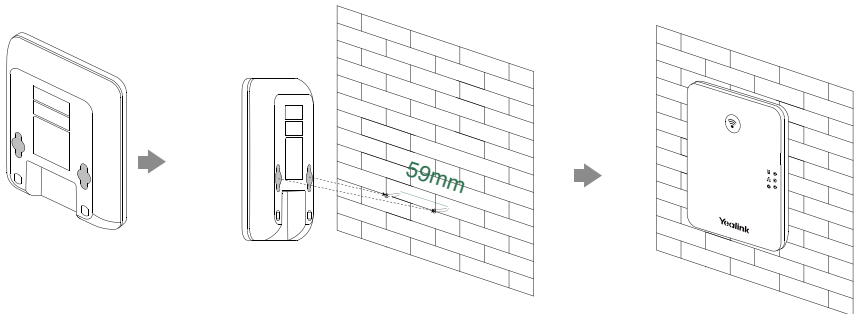

3. Legen Sie die Batterie in das Mobilteil ein.

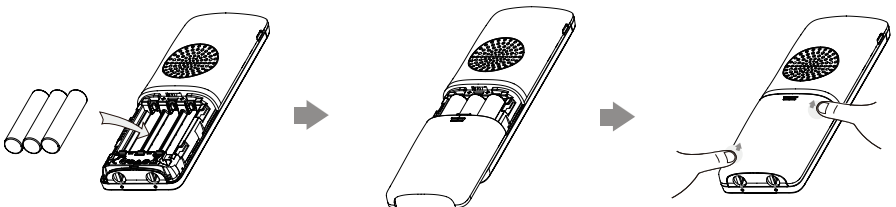

4. Befestigen Sie den Gürtelclip wie unten dargestellt:

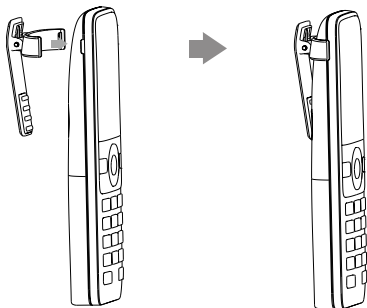

5. (Optional) Befestigen Sie die Ladestation wie unten dargestellt an der Wand:

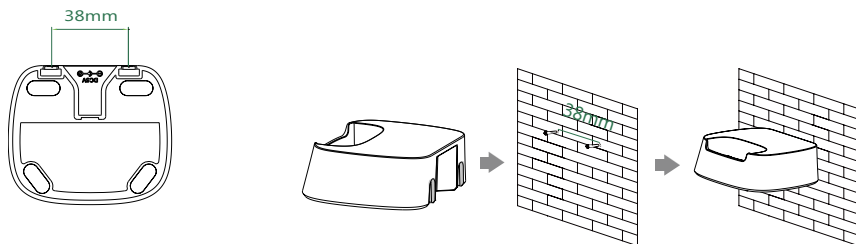

6. Verbinden Sie die Ladestation und laden Sie das Mobilteil auf.

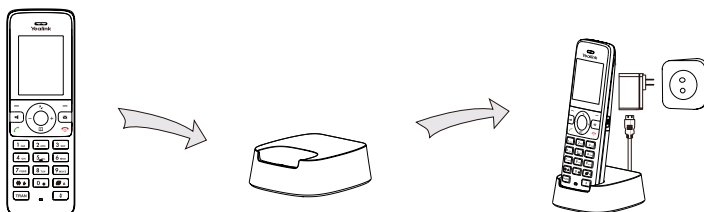

Hinweis:

- Verwenden Sie das von Yealink mitgelieferte Netzteil (5V/0.6A). Ein Netzteil eines Drittanbieters kann das Mobilteil beschädigen.
- Der Ladestatus des Mobilteils wird oben rechts im Display angezeigt.

Anleitung für die Hardware-Komponente

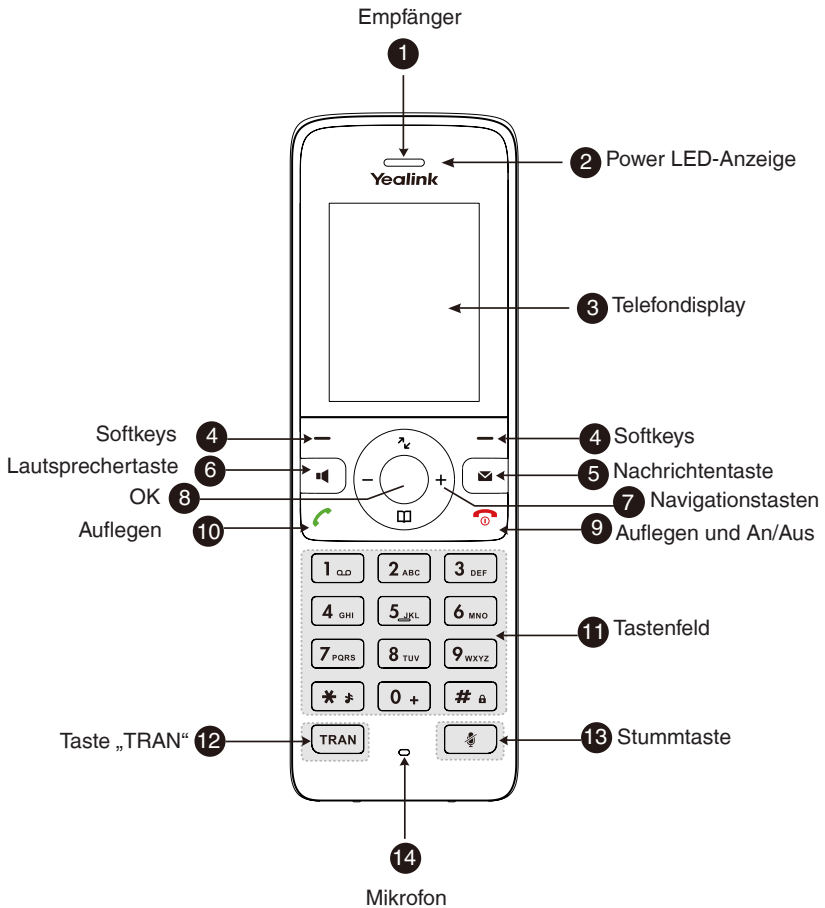



Declaration of Conformity

We, **YEALINK(XIAMEN) NETWORK TECHNOLOGY CO.,LTD**
Address: 309, 3rd Floor, No.16, Yun Ding North Road,
 Huli District, Xiamen City, Fujian, P.R. China
CE DATE: 20th /June/2021
 declare that the product:
Type: DECT IP Base Station
Model: W70B
 meets the essential requirements and other relevant provisions according to the following EC directive
Directive: 2014/30/EU, 2014/53/EU, RED 2014/53/EU;
 The presumption of conformity with the essential requirement is ensure according to :

Article 3.1 a (protection of the health & the safety of the user)
Safety: EN 62368-1:2014+A11:2017
SAR: ETSI EN 50663:2017, EN 62479:2010
 Article 3.1 b (protection requirement with respect to electromagnetic compatibility)
EMC: EN55032:2015 and EN55032:2015/A11:2020, EN55035:2017,
 EN 55035:2017/A11:2020, EN 61000-3-2:2014, EN 61000-3-2:2014,
 EN 61000-3-3:2013/A1:2019, EN 61000-3-3:2013/A1:2019
 EN301489-6 V2.2.1, EN301489-1 V2.2.3
 Article 3.2 (effective use of the radio spectrum)
Radio: ETSI EN 301406 V2.2.2

Directive 2011/65/EU and **(EU)2015/863** of the European Parliament and of the Council of 8 June 2011 and 4 June 2015 on the restriction of the use of certain hazardous substances in electrical and electronic equipment(RoHS 2.0)
Directive 2012/19/EU of the European Parliament and of the Council of 4 July 2012 on Waste electrical and electronic equipment(WEEE)
Regulation (EC) No.1907/2006 of the European Parliament and of the Council of 18 December 2006 on Registration, Evaluation, Authorization, and Restriction of Chemicals (REACH)

NAME: Huihu Wang
 DATE: 20th /June/2021
 TITLE: Sales Manager

Huihu Wang



Declaration of Conformity

Manufacturer: YEALINK(XIAMEN) NETWORK TECHNOLOGY CO., LTD.
Address: No.666 Hu'an Rd. Huli District Xiamen City, Fujian, P.R. China.
DATE: 15th/November/2025
 Declare that the product:
Product name: DECT IP Phone
Model: W73H
Brand: Yealink

Meets the essential requirements and other relevant provisions according to the following EU Directive **Radio Equipment Directive 2014/53/EU** Conformity

The product complies with the following standards:

Article 3.1 (a)	EN IEC 62368-1:2020+A11:2020 EN 62479:2010 EN 50663:2017
Article 3.1 (b)	EN 55032:2015+A1:2020; EN 55035:2017+A1:2020; EN 61000-3-2:2019+A2:2024; EN 61000-3-2:2013+A2:2021+AC:2022-01 ETSI EN 301 489-1 V2.2.3 (2019-11); ETSI EN 301 489-6 V2.2.1 (2019-04);
Article 3.2 Radio	ETSI EN 301 406 V2.2.2 (2016-09)

Harmonized: EN62321-1:2013

Commission Regulation (EU) 2023/1670 of 16 June 2023 according to Annex II, Chapter C, WIRELESS PHONES and Article 1 LOW POWER MODES.

Directive 2011/65/EU and **(EU)2015/863** of the European Parliament and of the Council of 8 June 2011 and 4 June 2015 on the restriction of the use of certain hazardous substances in electrical and electronic equipment(RoHS 2.0)

Directive 2012/19/EU of the European Parliament and of the Council of 4 July 2012 on Waste electrical and electronic equipment(WEEE)

Regulation (EC) No.1907/2006 of the European Parliament and of the Council of 18 December 2006 on Registration, Evaluation, Authorization, and Restriction of Chemicals (REACH)

This declaration of conformity is issued under the sole responsibility of the manufacturer.

NAME: Huihu Wang
 DATE:
 TITLE: Manager

Huihu Wang
 15/Nov/2025

Technical Support

Visit Yealink WIKI (<http://support.yealink.com/>) for the latest firmware, guides, FAQ, Product documents, and more. For better service, we sincerely recommend you to use Yealink Ticketing system (<https://ticket.yealink.com>) to submit all your technical issues.



430104003587



YEALINK(XIAMEN) NETWORK TECHNOLOGY CO.,LTD.
Web: www.yealink.com
Copyright©2026 YEALINK(XIAMEN) NETWORK
TECHNOLOGY CO.,LTD. All rights reserved.